



SISCO-HTGTB-5kVA/100kV-AC/DC Hipot Tester

USER MANUAL



SISCO Inc

Tel: +86 773-363-7977

Email:sales@sisco.com

Web: www.sisco.com

Contents

I. Summarize.....	2
II. Console.....	2
III. Transformer.....	6
IV. Principle.....	7
V. Connetion.....	8
VI. Pay attention.....	9
VII. Operation step.....	10
VIII. Working condition	11
IX. Storage.....	11
X. Packing list.....	11
XI. Troubleshooting.....	12

I. Summarize

SISCO-HTGTB-5kVA/100kV Power Frequency Withstand Voltage Test Set is produced according to the Mechanical and Electrical Department based on similar products in the original after a lot of improvement and produced. This series of products are with small volume, light weight, compact structure, functional, strong commonality and convenient use, etc., Especially suitable for power system, industrial and mining enterprises, scientific research departments and all kinds of pressure electric equipment, electric components, insulation material or DC power frequency dielectric strength under high-voltage test. It's essential for high-voltage test equipment.

II. Console

1. Advantage

Control unit is based on high-voltage test transformer's use of unique to design and produce, and its functions as below:

- A. Switch on sound and light alarms;
- B. Time sound and light alarms;
- C. Electronic low-voltage current protection;
- D. High voltage direct-reading;
- E. Voltage withstand test of time free to set up (digital);
- F. Mobile structures

2. Panel

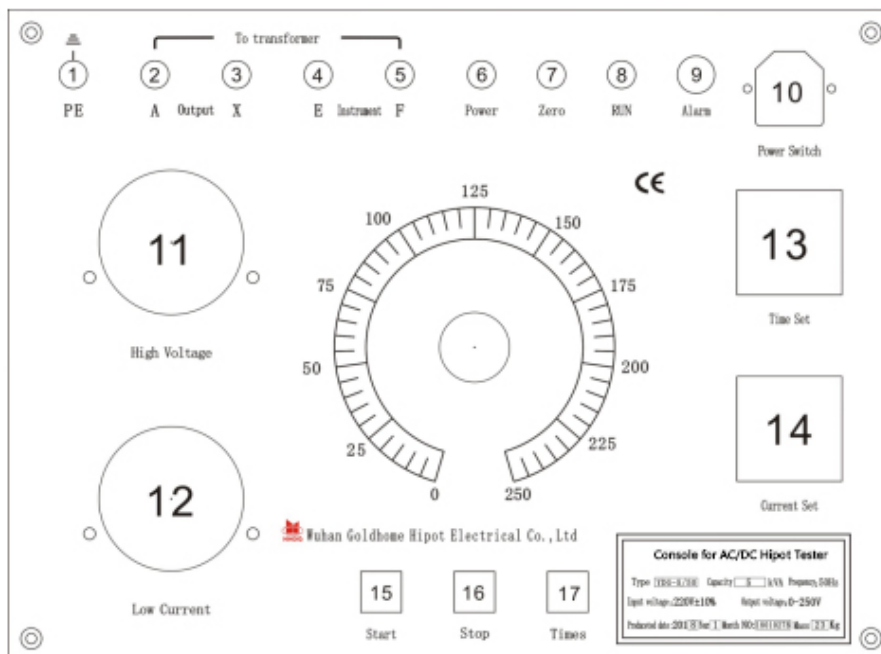

1. PE 2.3. Output 4.5. Instrument 6. Power 7. Zero
 8. Run 9. Alarm 10. Power Switch 11. High Voltage 12. Low Current
 13. Time Set 14. Current Set 15. Start 16. Stop 17. Times

4. working principles

This series of control box (console) is made up of a contact voltage regulator (electric voltage regulator above 50kVA column) and its controlling, protection, measurement, and signal circuit. It is through access to 220V or 380V AC power to regulate the voltage regulator (that is the input voltage of the test transformers), and to obtain the required value of test high voltage. Its working principles are shown as below:

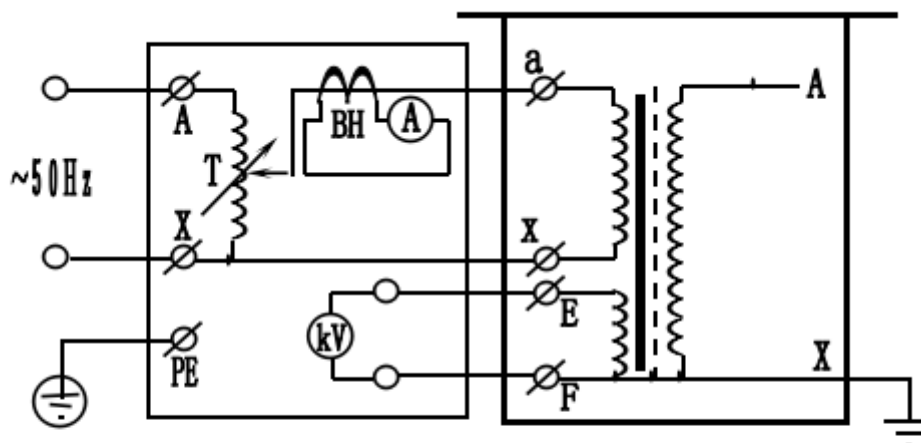

working principle of controlling box(console)

BH - current transformer (A) - ammeter
 (kV) - high voltage display table T - voltage regulator

5. Technical parameter

1. Input: 220V \pm 10% single phase, 50hz
2. Rated capacity: 5kVA
3. Input Current: 22.7A
4. Output voltage: 0~250V
5. Output current: 20A
6. Working time: \leq 2 mins
7. Ratio error: 1%
8. Cooling: natural cooling.
9. Size: 380 \times 280 \times 230(mm³), weight: 25Kg

6. Operation method for console

Before the operation was based on different sample capacity, voltage level, a good first calculate the maximum operating current, and adjust the current protection device.

The pilot should refer to the manual wiring of Figure 1 or the relevant test transformer connection diagram, should be a good grounding terminal (hereinafter, as the voltage test as an example).

1. Connected power supply (box-type for socket-type power supply, desktop power supply for the terminal), and voltage regulator to handle spin zero, the zero switch closed, the zero indicator (yellow) light, (also known as zero voltage regulator output status indication).
2. Press the start button (green), contactor pull-in, by the power regulator, while the work of light (red) light, and sound an alarm (siren left with zero voltage regulator, the police in order to stop the sound and light).
3. Clockwise rotation evenly slow regulator handle, and pay close attention to instrument readings, when high voltage to rise to the required value, should stop rotating, and timely press the timer button (yellow), at this time, Digital display time relay time shun time (time units for the "s", seconds), when the arrival time set, control box (Taiwan) to issue sound and light alarm, time, voltage regulator handle rotating in the opposite direction until the transfer back to zero voltage, the time to lift button.
5. In the boost or voltage withstand test process, as a result of short circuit, flashover, breakdown, such as over-current, the current trip of relay protection, automatic voltage regulator power that test materials are not up to standard, at this time regulator should be back to zero, cutting off power supply, inspect the test products.

III: Dry Type Transformer

1. Overview

The test also called transformer booster, which is used in areas of power supply equipment, all kinds of electrical products and tools and materials of insulation dielectric strength test.

Dry testing transformer series is produced, it is completely changed by the backward state of old test transformer stupid, big and heavy, it can produce our matching mounted on a high-voltage silicon stack to provide DC high-voltage test power supply, with a control box ,automatic protection microammeters, gap and other ancillary equipment. Especially suitable for testing at field, so that heavy work becomes convenient, rapid, easy and flexible, efficiency is greatly improved. As a result, it is well received by power systems and large test workers at large factories and mines.

2. Structure

This series are entirely new in design concept, material selection and process flow, so as to minimize volume and reduce weight without reducing performance.

This series use of advanced production equipment, CD type iron core coil winding epoxy vacuum casting and winding with high quality cold-rolled silicon steel, effectively weakening the magnetic leakage, do DC voltage test without external silicon pile, only the DC high voltage silicon company supporting the stack installed in the high voltage side can be obtained dc.

3. Advantage

1. Epoxy resin vacuum casting and CD type iron core structure technology
2. Small size, light weight and compact structure, noleakage, maintenance free;
3. Simple wiring, easy to use;
4. Reliable Insulation, beautiful appearance;
5. Over voltage protection function

4. Technical data

- Output voltage: AC: 0-100KV; DC: 0-140KV
- Output current: AC 0- 50mA; DC: 0-35mA
- Impedance voltage: <12%
- Surface temperature-raising: < 55°C
- No-load current: < 4%
- Continuous working time: ≤ 60 mins (DC Testing)
- Output voltage waveform: sine wave, power frequency
- Net weight: 40kg

III. Working principle

The series input voltage 200V or 400V supporting access control box, the auto transformer to adjust the input voltage to test the transformer primary winding (low voltage), based on the principle of electromagnetic induction in the secondary winding (high pressure) to obtain the output voltage according to the ratio of the same ratio with the primary winding turns, from the highest value to zero volts continuous rated. In DC voltage test and leakage current test, as long as the high voltage silicon stack is installed on the high voltage output terminal, the DC high voltage can be obtained, and its amplitude is 1.414 times of the high frequency power value.

Schematic diagram

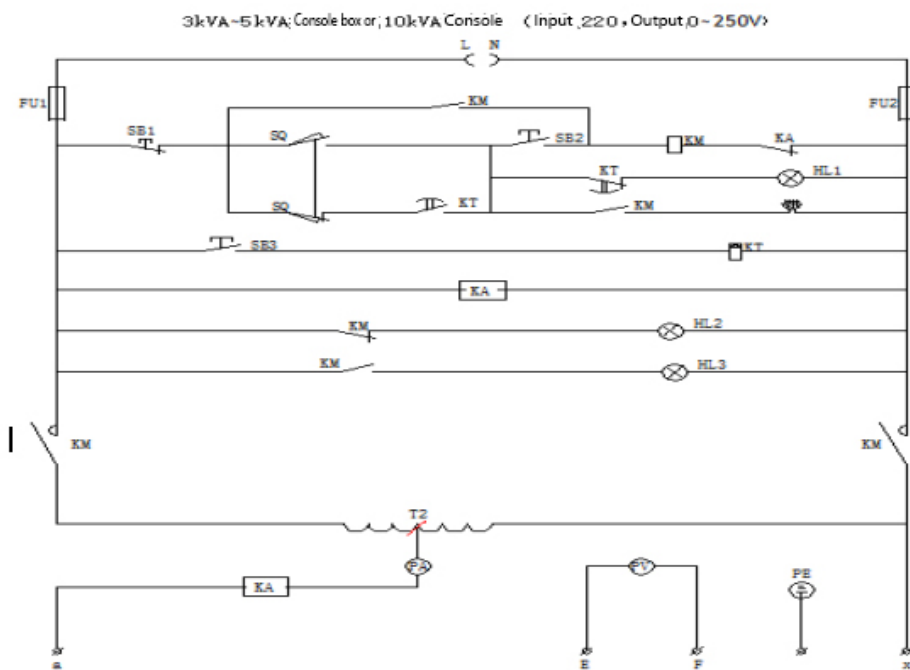
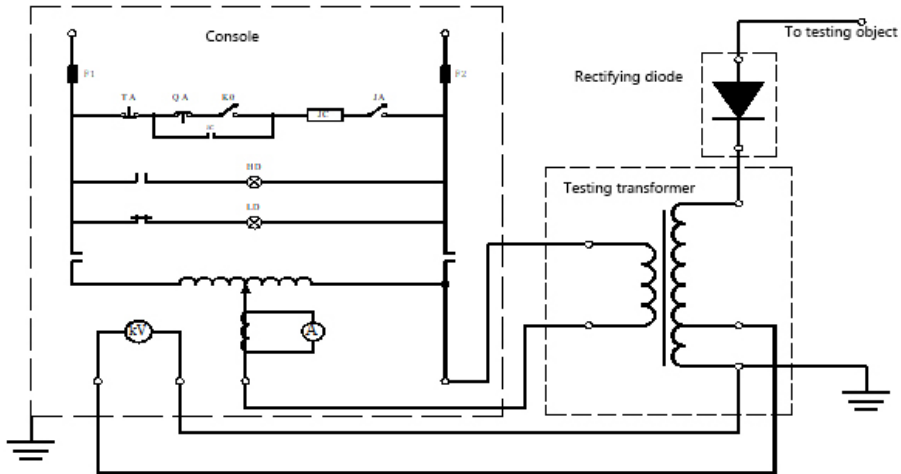

Controller

V. Connection method for power frequency withstand voltage test

1. AC Testing:

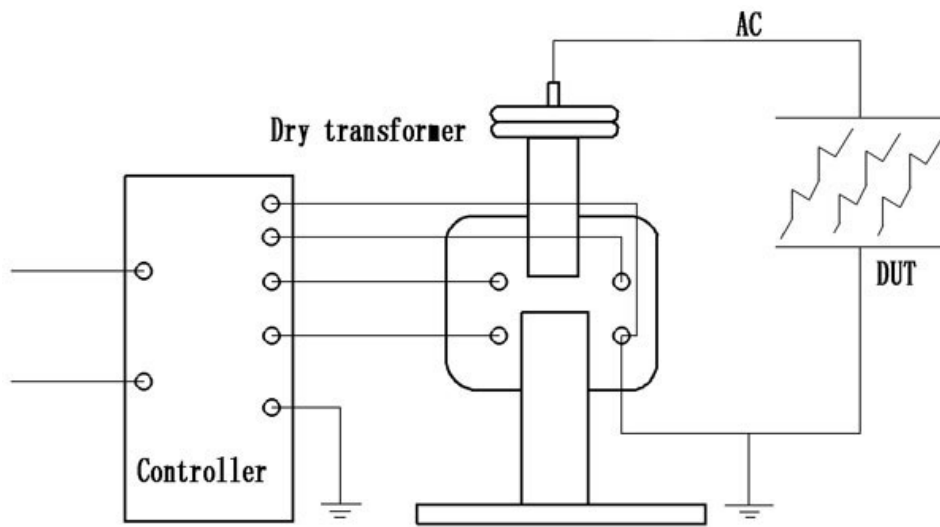

2. DC Testing

2.DC testing

Below is sett

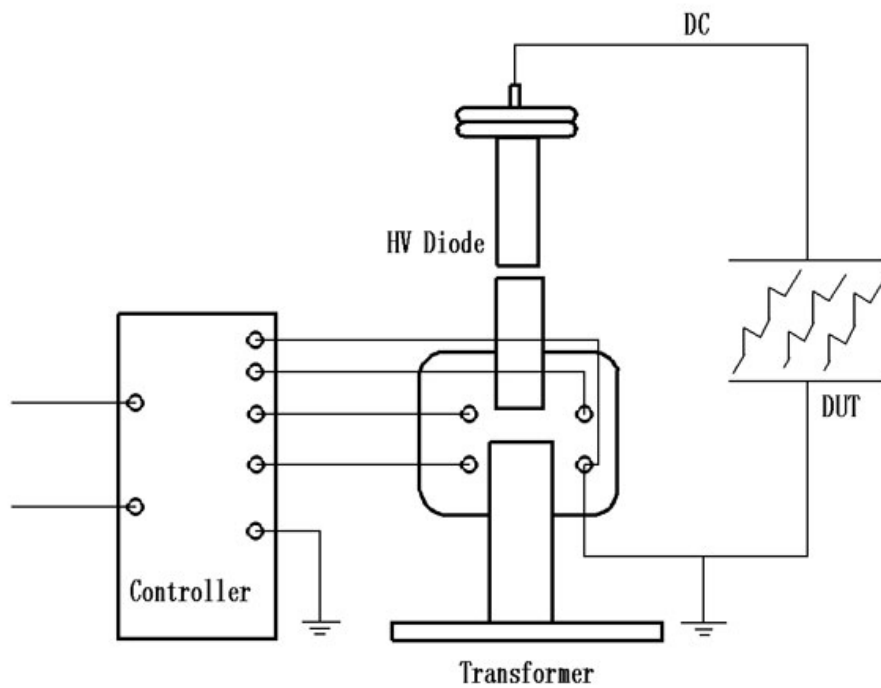

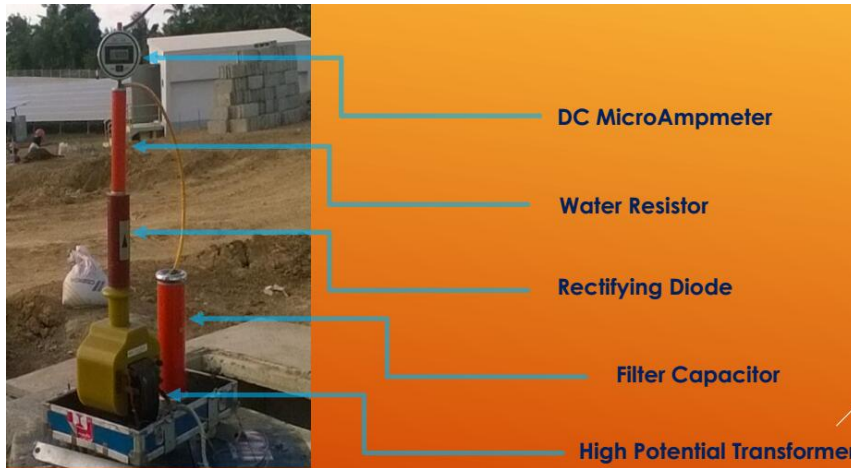

VI. Operation

- 1) Before testing, it is necessary to connect transformer't HV end terminal “⊥” to grounding, otherwise it is dangerous.
- 2) Before testing, the operator must be familiar with the electrical principle and use method of test transformer.
- 3) Connecting cables according to wiring diagram.
- 4) Preparation and safety inspection are ready, test the equipment without load.
- 5) Connecting to device under test (DUT).
- 6) Power supply on, controller's power indicator lights.
- 7) Operation details as per “Operation instruction” of control unit.
- 8) Press closing button and turn on indicator light.
- 9) Carefully boost voltage with clockwise, watch meter's voltage amplitude and test condition until the rated test voltage to be reached.
- 10) Continue to specify the withstand time and watch ammeter and device under testing.
- 11) When time is up, observe the “kV” meter, and quickly adjust regulator back to “0” position, finally power off.
- 12) Discharging with dischrage rod, then grounding discharging.
- 13) Discharging every high voltage part may be discharged, removing connections, testing is finished.

VII. Pay attention

1. Connect the work line according to your ongoing experiments. The crust of experimental transformer and operating system must earthing realiaibly. The X end (high voltage tail) of experimental transformer high-voltage winding and the F end of measuring winding must earthing realiaibly.
2. When doing cascade testing, the low-voltage windings X-side of the second grade

and third grade test transformer, the F-side of measurement windings and high-voltage windings X-side (high pressure tail) are all connected to the shell of the test transformer. The second grade, third grade test transformer' bracket shell must be grounded through the insulation.

3. Connected to power before the voltage regulator of the operating system must be zero to be connected, switched on, beginning to step up.
4. Start from zero to step up by pressure regulator, step-up method: rapid step-up method, Step-up method that is level 20s; Slow Step Method, Step-up method that is level 60s, A very slow step-up method for the selection of. Voltage step-up from scratch by a certain way and at a rate up to your desired test voltage rating of 75% in 2% per second at the rated voltage of the speed test you need to rise to the rated voltage And pay close attention to the direction of measuring instruments as well as the test case goods Step-up the process or testing the process of measuring instruments, such as found in the instructions and sample cases were abnormal Blood pressure should be immediate, Cut off the power supply, the identification of the situation.
5. After the test, it should be uniform within seconds of the regulator to return to zero, and then cut off the power
6. This product is used must not exceed the rated parameters. In addition to the pilot to be outside and will never allow full voltage electricity or power.
7. The use of the product high-voltage test, the familiar with the specification, but also to strictly enforce the state standards and procedures.

VIII. Operation condition

1. Environmental temperature : 0-40 °C;
2. Altitude: <1000m;
3. Relative humidity: <85%;
4. Workplace should be no gas, steam, chemical dust which seriously affect the insulation and other explosive and corrosive media.



IX. Storage

The product should be placed in ventilated, cool and dry cleaning position, Pay attention to moisture, prevent corrosive gas.

IIX. Packing list





Sr no	Description	Qty
1	Hipot Test Set (1 control unit +1 transformer)	1
2	Connecting cable (Power supply, Earth test)	1 set
3	Operating manual	1
4	Rectifying diode	1



XI. Troubleshooting

Name	Components and parts	Functions	Fault	Changing method
Overcurrent setting relay		Protection current setting from the controller output to transformer (max setting 25A), "KA"	Not normal start, protection current setting inaccurate	Removing the fixed screw on the panel, pull out the over-current/voltage cables and exchange them.
KV indicator		HV output	Inaccurate indication of high voltage, pointer don't move, high voltage indication inaccurate	Removing the fixed screw on the panel, pull out the pointer's screws, newly connect cables and exchange them.
Stop/Start button		"SB1" "SB2" Marked in manual	Not normal to start and stop	Remove the fixed screws of panel, weld the wiring bundle to re weld the wiring bundle and replace

Zero position protection start switch		“SQ” Marked in manual	It is not normal to start, zero indicator light is not bright	Remove the fixed screws of panel, weld the wiring bundle to re weld the wiring bundle and replace
---------------------------------------	---	--------------------------	---	---

Packing list

No.	Description	Parts	Qty
1	Controller		1
2	Dry Transformer		1
3	Power supply cable		1
4	Earth cable		1
5	Connecting line		1

6	Fuse		3
7	Rectifying Diode		1
8	Discharge rod		1
9	Operating manual		1
10	Testing report		1

Specification

Specification	Capacity	Input	Ouput	Current	DC Output	Weight	
	(kVA)	(V)	(kV)	(mA)	(kV)	(kg)	
1.5/50	1.5	200 or 400	50	30	70	15	
3/50	3			60		20	
5/50	5			100		30	
10/50	10			200		40	
15/50	15			300		50	
20/50	20			400		55	
25/50	25			500		60	
30/50	30			600		65	
5/100	5			200 or 400		100	50
10/100	10	100	65				
15/100	15	150	70				
20/100	20	200	75				
25/100	25	250	80				
15/120	15	400	120		125		
20/120	20				160		90
25/120	25				200		95
30/120	30				250		100